

THE PMI AUTOMATED GAS PERMEAMETER (with confining Pressure)

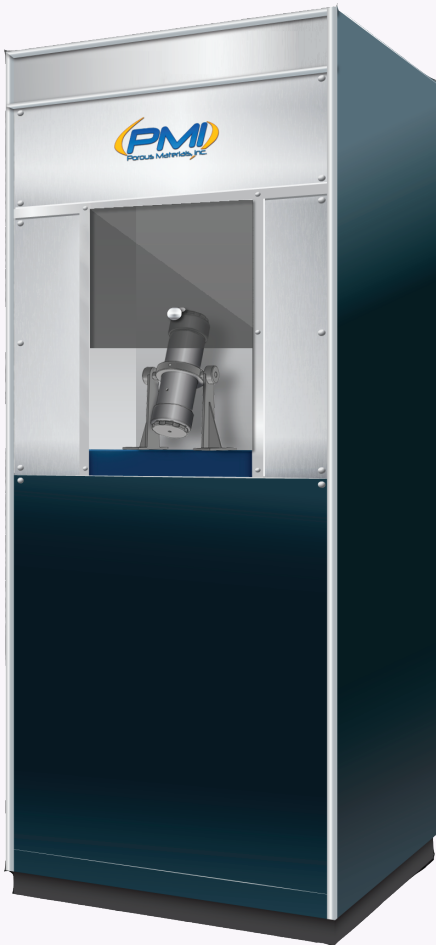

GP-100A



Not just products...solutions.

Permeameter Principle

The PMI Advanced Multi Sample Permeameter is used to measure gas permeability of samples such as oil well cores, tight gas sandstones and other very low permeability rock. The system creates a differential pressure across the core and monitors the resulting pressure decay over time using the unsteady state method.. PMI software utilizes this data along with known system volumes to calculate permeability.

Description

The rock core sample is loaded in a holder and confining pressure is applied. The system is then charged with test gas to the desired pore pressure. Adequate time is given to allow this pressure to fully saturate the sample. After reaching equilibrium the upstream and downstream portions of the system are isolated from each other. A pulse is then created by raising the upstream pressure (or lowering the downstream pressure). Data is recorded throughout this process and is used in conjunction with known system volumes to calculate gas flow rates and permeability.

An optional heating system is available to test samples at elevated temperature, and the system is capable of maintaining a constant upstream and/or downstream pressure throughout the test if desired. All components are housed in an insulated, temperature controlled cabinet to mitigate the effect of ambient temperature fluctuations.

The equipment is fully automated. Execution of the test, data acquisition, data storage and data management are all carried out by PMI Software. Operator involvement is minimal, and the instrument is robust and requires a minimal amount of care.

Figure 1
Outline of permeability testing setup

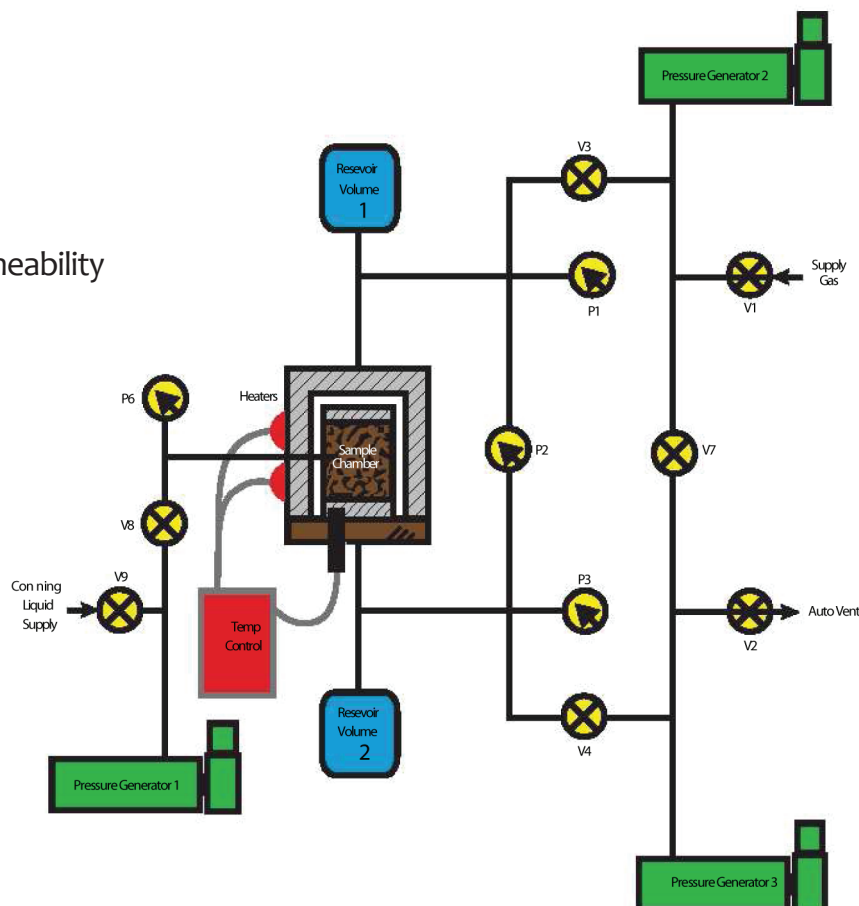

Permeameter Application

Industries worldwide utilize PMI Permeameters like the PMI Advanced Multi Sample Permeameter/Porosimeter for research and development and quality control. Uses Boyles Law and software calculation of Klinkenberg. Applicable industries include: Oil refineries, Oil and gas exploration, Geotechnical, Geophysics, Automotive and Battery development.

Core Holder

A Hassler type core holder with up to 10,000 PSI confining pressure. Features quick release aluminium core holder to accommodate core holders custom manufactured to meet your testing needs.

Operating Procedure

PMI's Advanced Gas Porosimeter is fully automatic, provides high-speed, high-precision volume measurements and density calculations. The instrument uses Helium drawn into a reference volume, and is stabilized at around 100psi. Core samples are held in a matrix cup and isolated by valves, then helium is expanded into the sample chamber. When the pressure stabilizes, the pressure is recorded. Sample grain volume is determined using comparison to calibration disks of a known volume.

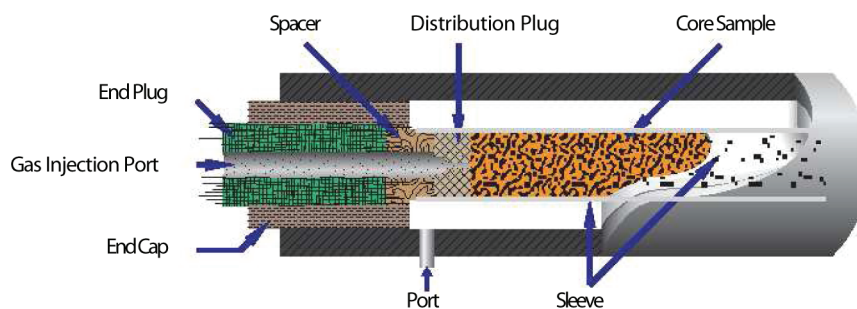
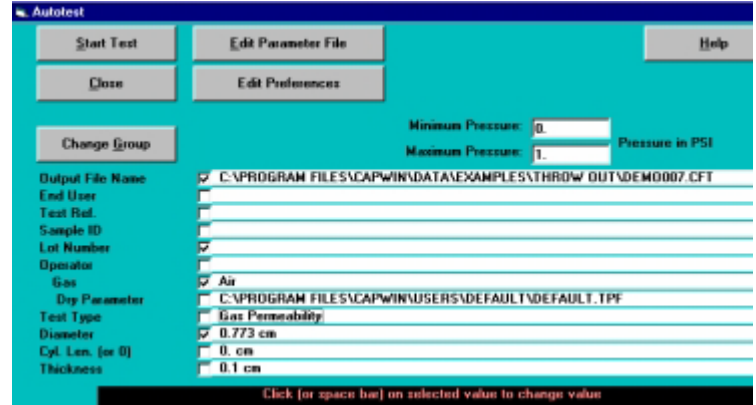
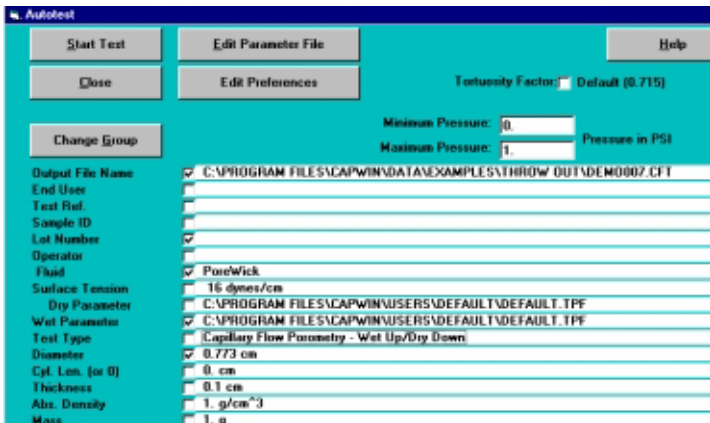

Figure 1
Core holder and sample chamber

Programme Snapshot



Output File Name C:\PROGRAM FILES\CAPWIN\DATA\EXAMPLES\THROW OUT\DEM0007.CFT

Diameter 0.773 cm

Cyl. Len. (or Ø) 0. cm

Thickness 0.1 cm

End User

Test Ref.

Sample ID

Lot Number

Operator

Gas Air

Dry Parameter C:\PROGRAM FILES\CAPWIN\USERS\DEFAULT\DEFAULT.TPF

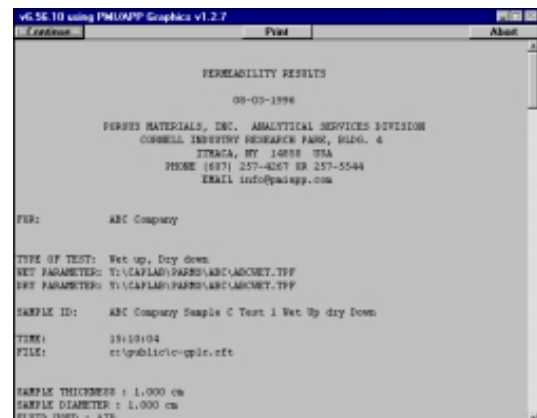
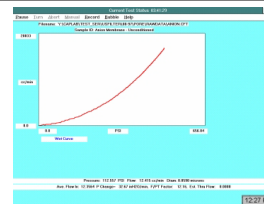
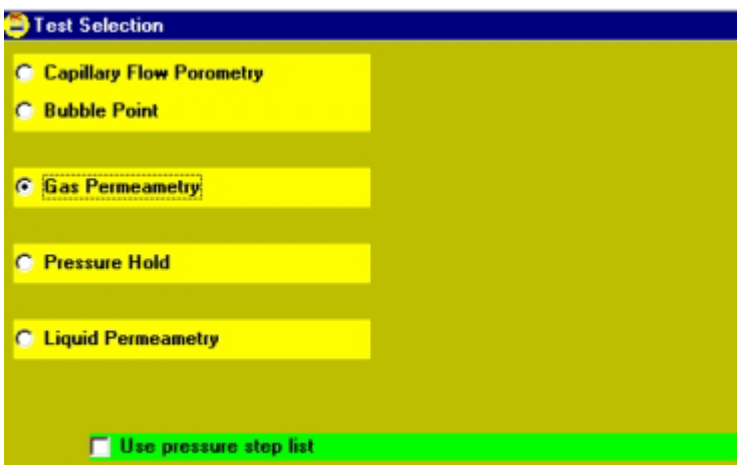
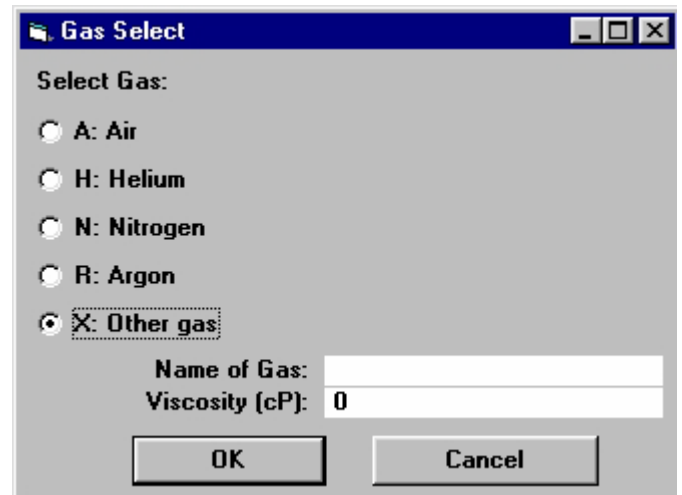
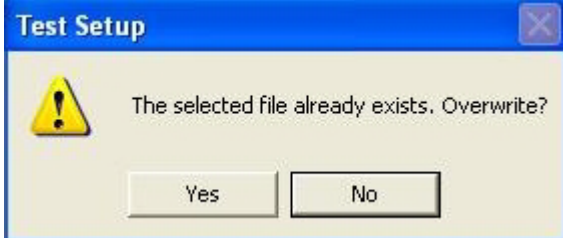

Description

A rock sample is held in the sample chamber and compressive stress is applied. While the sample is under compressive stress, the desired properties are measured.

The PMI Automated Porosimeter System has been specially designed for testing core samples. Core samples are held in a sleeve which (pneumatic or hydraulic) compresses the sample. The instrument

measures the loss of a known amount of gas to computer porosity.

The equipment is fully automated. Execution of the test, data acquisition, data storage, & data management are all carried out by PMI software. Operator involvement is minimal, and the instrument is robust and requires a minimal amount of care.

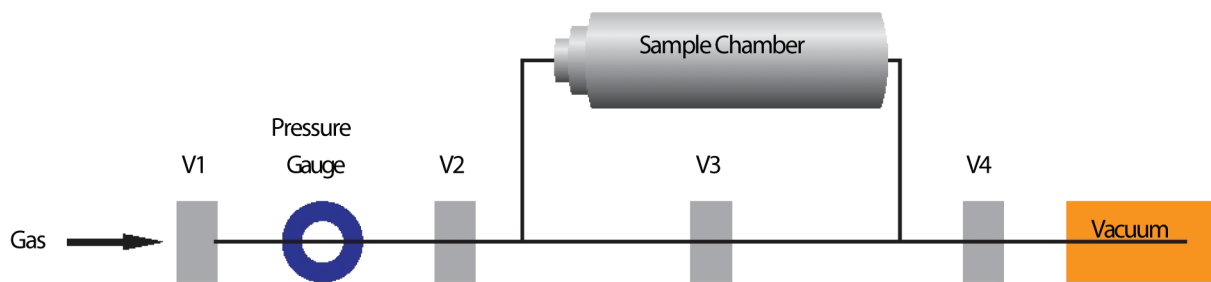

Figure 2

PMI Gas Helium Porosimeter outline for testing

Software Features

- Capable to be programmed for automatic repeat measurements or for data acquisition under user selected tolerances.
- Graphic presentation of the data to be evaluated and analysis results
- Exporting graphic files to window based word / excel processing files for report generation
- Provision for off-line data processing.
- Integrated detailed help system

Data Acquisition

APC is required for data display and acquisition, display and analysis. Interface between The necessary software for analysis, data equipment and PC acquisition, and experiment control is included with the unit Serial communications port includes connection to optional printer and computer. Output uses excel compatible spreadsheet calculations for data analysis.

Specifications*

- Confining Pressure: 400 to 10,000 PSI or better
- Pore Pressure: 0 to 250 psi & more
- Permeability Range: < 0.001 to > 10,000 md
- Accuracy: 0.5% or better
- Porosity Range: 1% to 60%
- Power Requirements: 220 VAC \pm 10%, 50 Hz \pm 1 Hz, single phase
- Plug sample length: from 0.75" to 3"
- Plug samples capable of being loaded for auto tester:
13 of 1.5" diameter or 16 of 1.0" diameter

Features

- User-friendly Windows based software handles all control, measurement, data collection and report generation.
- Complete manual control from software
- Non-destructive testing
- Length of test varies with sample, test to 7 days or more continuously
- All key components are insulated to eliminate possible error due to fluctuations in ambient temperature

Items Provided

- Standard calibration plugs (1 inch and 1.5 inch diameter)
- 5 Porosity calibration/check plugs of different values for 1.0" and 5 for 1.5" samples
- 5 Permeability calibration/check plugs of different values for 1.0" and 5 for 1.5" samples
- Equipment necessary for core preparation, including plugging machine for 1" and 1.5" diameter cores and end grinder
- Spare parts for up to three years of regular use operation

Instrument Parameters

Software computes: Pore volume, Bulk Volume, Porosity, Permeability (Air permeability & Klinkenberg permeability), Grain density, Bulk density, Slip factor 'b'

- * Other specifications for this machine are available. Specifications are subject to change without notice.



**The most advanced, accurate, easy to use
and reproducible porometers in the world.**

Celebrating



of solutions



20 Dutch Mill Rd, Ithaca, NY 14850, USA
Toll Free (US & Canada): 1-800-TALK-PMI (1-800-825-5764) Phone:
607-257-5544 Fax: 607-257-5639

Email: info@pmiapp.com www.pmiapp.com